

# 4

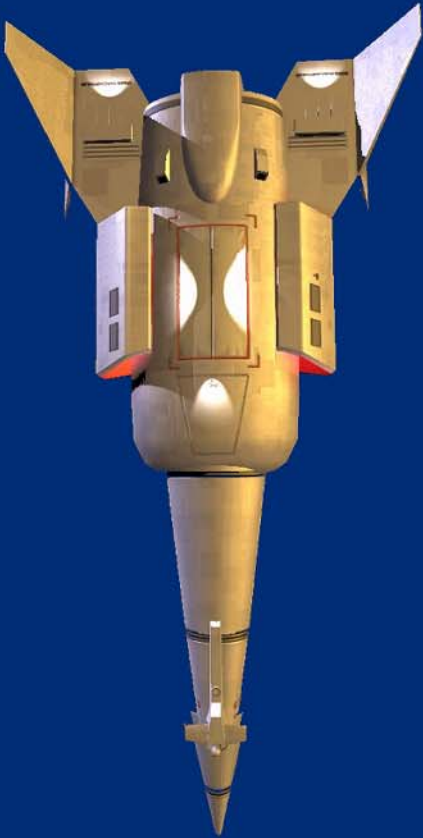

# FEDERATION SPACEFLIGHT CHRONOLOGY

**TERRAN ORIENTATION**

**TERRANGOLO LANGUAGE EDITION**



**AUTHORIZED  
PERSONNEL ONLY**  
SECURITY LEVEL TWO

Original texts and manuscript concept copyright © 2007 by Richard E. Mandel

*STAR TREK*, its on-screen derivatives, and all associated materials are the property of Paramount Pictures Corporation. Multiple references in this document are given under the terms of fair use with regard to international copyright and trademark law. This is a scholarly reference work intended to explain the background and historical aspects of *STAR TREK* and its spacecraft technology and is not sponsored, approved, or authorized by Paramount Pictures and its affiliated licensees.

All visual materials included herein is protected by either implied or statutory copyright and are reproduced either with the permission of the copyright holder or under the terms of fair use as defined under current international copyright law.

All visual materials used in this work without clearance were obtained from public sources through public means and were believed to be in the public domain or available for inclusion via the fair use doctrine at the time of printing.

This work is dedicated to Geoffery Mandel, who started it for all of us.

Memory Alpha and SFHQ/Mastercom cataloging data:  
UFP/SFD DTA HR:217622

# PART FOUR

## 2049-2065: THE EARTH-KZIN WARS

### OVERVIEW

#### TIMELINE OF MAJOR EVENTS

#### STARSHIPS

KZINTI PATROL CRUISER  
DY-350 *BLACK MAMBA* DESTROYER  
DY-550 SERIES  
*MAHAN* CLASS HEAVY CRUISER  
DY-X ASSAULT CRUISER  
*LIBERTY* CLASS SCOUT  
*COCHRANE* CLASS EXPLORER  
*VERNE* CLASS SURVEY CRUISER  
*KELDYSH* CLASS EXPLORER

#### ALIEN ENCOUNTERS

THE KZINTI

#### TERRAN EXPLORATIONS

KZIN (61 URSAE MAJORIS IV)

#### HISTORICAL ARTICLES

KASHI SHOWA STATION MISSING  
BRYNNER CITY DESTROYED BY KZINTI  
ALPHA CENTAURI BELONGS TO KZIN  
COCHRANE AND *ENTERPRISE* M.I.A.  
ALPHA CENTAURI LIBERATED  
STAR FLEET OFFENSIVE STALLS  
THE ROCK IS DROPPED  
HALLEY'S COMET BREAKS UP  
MARS DECLARES INDEPENDENCE  
WARP DRIVE BECOMES REALITY  
THE WAR IS OVER!

#### SCHEMATICS

#### ACKNOWLEDGEMENTS

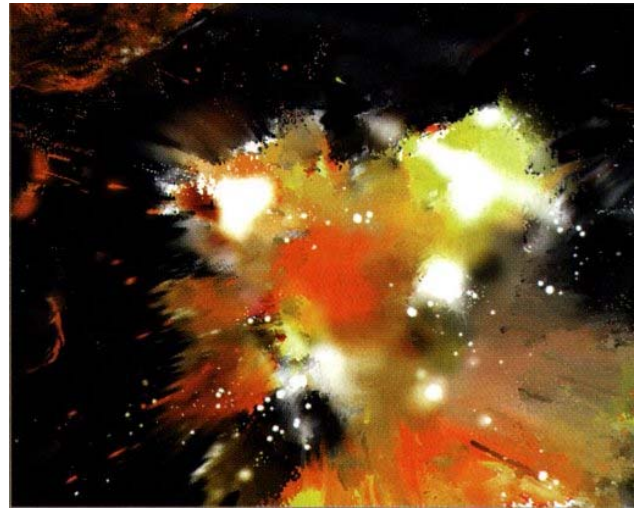

A Kzinti cruiser explodes (2051)



Operation Rock Drop (2060)



DY-100 (1995) and DY-X (2065)  
Painting courtesy Dyson-Yoyodyne Intersystems, LTD.

# Special Notice

---

Due to the subject matter of this volume and the dates involved, the period of years covered by this and the following installment of the *Federation Spaceflight Chronology* have been adjusted from their normal 25-year pattern. This volume is devoted exclusively to the Earth-Kzin Wars, which occurred from 2049 to 2065. The next volume covers Terra's acceptance into the Local Group's spacefaring cultures, with the cutoff at 2100 per the normal study pattern. We at Star Fleet Academy Training Command apologize for any confusion that this may cause midshipmen in their studies.

RADM Charles Westerfield, Commandant  
Star Fleet Academy, Terra, San Francisco, 2295



# 2049-2065: The Earth-Kzin Wars

---



In 2048 humanity got their first contact with an intelligent, non-terrestrial, non-human species that certain of its members had for so long desired. They had hoped, prayed, built their dreams on such an encounter, imagining it to be a benevolent and peaceful exchange with a rational, highly advanced alien race that would accept humanity for the stumbling yet promising species that it was.

What they got instead were the Kzinti.

The Earth-Kzin Wars were a bloody landmark in humanity's quest for the stars. They were a brutal wake-up call to the fact that not all aliens were going to be the benevolent and peaceful species for who New Age types had for so long yearned. Like every species before them who had run afoul of Kzin, humanity had a simple choice. It could either be conquered or fight to survive. Humanity understandably chose the latter. What made them different from almost other cultures that had made the same choice, though, was that they took it one step further. They took the war to the Kzinti. They fought back with a determination and savagery that rivaled that of their feline foes. At the same time, however, they managed to keep from falling into the well of martial depravity for which the Kzinti were legend. Somehow, despite everything they suffered,

humanity never lost its nobility, its compassion, its sense of justice balanced with mercy.

---

By the time the final death toll was compiled from the First Earth-Kzin War, in which humanity fought to save its very freedom and newly-found place in the stars from its would-be feline oppressors, more than 4,500 humans had died and over 13,000 injured in both the Sol and Centaurean star systems. That was only the beginning. It was a drop in the bucket compared to the casualty figures that were about to be racked up. There was another attack wave on the way and more behind them. Information gleaned from wrecked Kzinti ships and some of the dying crewmen aboard them had made this all too clear. The standard Kzinti tactic for dealing with a new foe was to send several fleets every few years, starting with the ones closest to the new threat, in massed wave attacks until either their new foe was beaten or proved unbeatable. The data did not reveal the identity of the "unbeatables."

UESF Major General Hans Dietrich, now the Unified Field Commander of both Terran and Centaurean forces, wanted to make clear to the Kzinti that humanity were definitely among the "unbeatables." He therefore began planning a long-term strategy designed to put the Kzinti out of action as soon as possible. In the short term this meant quickly rebuilding the combined fleets and filling them with new ships that had the armament and maneuverability to deal with their foe. In the long term this meant finding a way to strike at the Kzinti so as to break up their staggered massed-wave tactics. The first part was easy, relatively speaking. The second part would be harder, given that Terran ships were still limited to sublight velocities. Zephram Cochrane's new warp drive wouldn't become practical for at least another decade, given current estimates, and by then it might be too late. Another way had to be found to short-circuit the Kzin battle plan before

their sheer numbers finally took their toll on Dietrich's available resources.

Perhaps the most important discovery of the war at this time was made while Terran and Centaurean scientists were reverse-engineering captured Kzinti technology. They learned that the Kzin already possessed a form of warp drive. It was crude and incapable of sustained use. Instead, Kzinti ships would "jump" from point to point and then spend a fair amount of time in between recharging their engines for the next jump. This explained why they could travel anywhere they wanted in the Local Group within two years' time. It was officially dubbed the *continuum distortion propulsion* (CDP) generator after current Terran experiments along the same lines. It was similar to the CDP generator technology that was being tested at Kashishowa Station prior to its destruction in 2053. Most humans called it the "jump drive" for short. It allowed Kzinti ships to make light-speed "jumps" across enormous distances, pausing in between to rebuild their energy for another "jump." Kzinti energy generation technology was roughly on the same level as humanity's, though, which meant that the engines of their ships simply weren't up to the massive power requirements involved for sustained cruising; hence the "jump drive."

When a captured Kzinti officer was asked how they came up with the CDP engine, he is said to have smiled and then snarled, "We didn't. The pig-men did. We took it from them. Made them build it for us. But that was long ago. We fight you now. You will meet them soon, when you lie beside their bones on our dinner tables. Softskins like you, but with hair like us and hooves for claws. Very fat. Very tasty." The full import of his words would not be understood until first contact was made with the Tellarites in 2073.

During the war, when one of the few rare intelligent *kzinretti* escaped captivity by her people and fled to human-controlled space, humanity welcomed her with open arms. She was not treated as a second-class citizen, nor was she made an object for public spectacle. She was treated as a true equal, an

intelligent being in her own right no different from a human save for the fur on her skin. The freedom that she now enjoyed was almost too much for her to comprehend. When she was asked if she had a name, she merely shook her head, saying that in her culture females didn't deserve names. When her hosts kindly asked her if she would like to have her very own name, she immediately broke down in tears. This spoke much of man's nobility during the Earth-Kzin Wars. They would be rewarded for that nobility within months of the war's end.

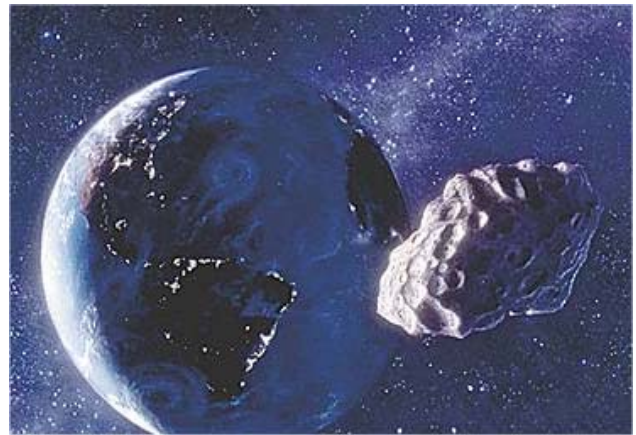

Much has been made by the historians of Operation Rock Drop, the incredible event that brought an end to the Third Earth-Kzin War. It would have been impossible to achieve, let alone attempt, had it not been for the alien device found at Sidonia on Mars decades earlier. After years of others failing to unlock its mysteries, General Dietrich's new scientific advisor somehow managed to discern its purpose. It was an artificial wormhole generator, the first (and still only) ever discovered by man, designed to open a tunnel in space from one point to another. No one knew why the "Builders" had left it behind, nor did General Dietrich frankly care. Dietrich also remembered an asteroid in orbit around the Sol System that at one time had been a comet and was fitted with fusion engines to keep it from hitting Terra. He had in his hands both the means and method to deal the Kzinti a crushing, possibly fatal blow, provided a way could be found to power and operate the device. Dietrich was not surprised when his new scientific advisor, a man of considerable genius, quickly found a way to power the device and



make it operational. Thus was Operation Rock Drop born.

Any future plans Dietrich might have had for his new device were shattered when a Kzinti battle fleet attacked his own, just as Operation Rock Drop was getting underway. The battle was eventually won and Operation Rock Drop a success, with the planet Kzin devastated by the asteroid strike; however, Dietrich's fleet suffered many casualties during the fight. Among these was his new scientific advisor, who was lost when the science section of Dietrich's flagship *Indomitable* was hulled during the battle. The alien wormhole generator was also wrecked beyond repair. They were both irreplaceable and the hand of Fate would never deal humanity such cards again in the Earth-Kzin Wars. General Dietrich consoled himself with the fact that they had bought enough time for Star Fleet's new warp drive ships to come on line. When the Kzinti came back, and they undoubtedly would once they had recovered sufficiently, Star Fleet would be ready for them. Star Fleet would be waiting with a fleet of ships the Kzinti could not possibly hope to defeat. On that day the Kzinti would go down and never menace humanity again.



The Earth-Kzin Wars eventually broke the back of the Kzinti Empire. Many of its former occupied systems promptly overthrew their Kzinti garrisons and declared their freedom after the fourth and final war. These would be eager to be affiliated with the Federation once that arose a few decades later, never again wanting to suffer brutal occupation as they had done under the Kzinti paw. Several of the Kzinti border sectors or former servitor races, though, broke away from the quickly collapsing Empire and declared their independence as stellar powers in their own right. These still thirsted for conquest in

true Kzinti fashion and humanity would learn their names in turn. The savage M'Dok ... the lizard-like Tzenkethi ... and the genetically engineered Kzinti offshoots of the Mirak Star League ... these were the ones who, along with the shrunken Patriarchy, would continue to trouble the spaceways for decades to come. Humanity would be there to challenge them, though, along with many newfound allies whose respect they had forever earned in their long and bloody struggle with the Kzinti.

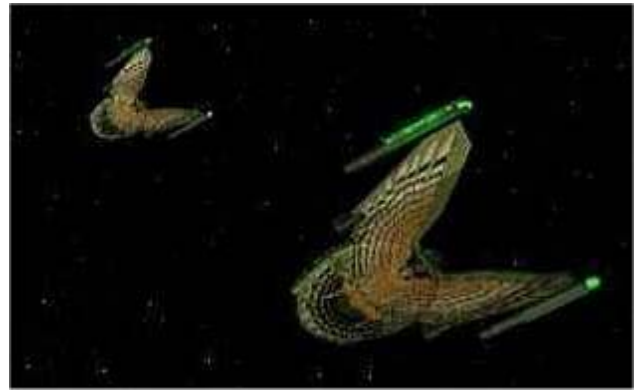

Meanwhile, on the other side of former Kzin space, two rising interstellar forces sensed the shift in the balance of power along their borders. They began to push back the disorganized and disheartened Kzinti border fleets, expanding their own empires at the sake of their former foe. It would be over a century before the first of these would encounter humanity, and another half-century more before the other had its encounter. The Local Group and its newly added territories might be safe for now, but there were two other future foes already lurking over the distant horizon.

Miklos Sophia  
*The Rise and Fall of the Kzinti Empire*

# MAJOR EVENTS

## 2049-2050

- The First Earth-Kzin War

## 2049

- The colony ship *Hawking* launches from Terra.
- The *Adam & Eve* is destroyed by the Kzinti just short of its goal of reaching Barnard's Star.
- The First Battle of Alpha Centauri.
- Alpha Centauri is attacked by a Kzinti battle fleet looking for the homeworld of the *Sakharov*. A combined Terran-Centaurean effort is able to drive them away through the use of portable mass drivers converted into giant "space shotguns." This marks the first time that the humans of Terra and Alpha Centauri have worked together on a joint enterprise.
- The Terran vessel *Icarus* takes heavy damage during the Battle of Alpha Centauri. It is forced to lay over for several months longer than planned in order to effect repairs.
- The inventiveness and vigorous tenacity of the humans surprises the Kzinti. They had no idea that the "softskins" would prove to be such formidable opponents.
- One small boon gained by the Kzinti during the Battle of Alpha Centauri is that they learn the location of Terra. A second battle fleet already enroute to Alpha Centauri is rerouted towards the Sol System.
- Upon hearing the news of the Kzinti attack the New United Nations declares martial law in those sectors of Terra it still controls. All civilian craft are appropriated by the UESF, armed, and pressed into emergency service. What remains of Terra's orbital weapons network is redeployed outward. Work begins on converting the Sol System's interplanetary "beam rider" laser network into a defensive weapon. Mass drivers are deployed across the Sol System at all key points in anticipation of the impending attack.
- Zephram Cochrane's efforts into turning his warp drive theory into a practical reality are given a sudden boost by both the Terran and Centaurean governments. He doesn't care about the new Earth-Kzin war; however, he gladly welcomes the new funding and resources without question.



- Sol System activity in the Terran space colonies continues to boom via new industrial methods, boosting the Gross Solar Product yet again.
- The *Monticello* class cargo carrier enters service.

## 2050

- The First Battle of the Sol System.
- A Kzinti battle fleet arrives at the Sol System and begins to systematically attack its outer outposts and UESF bases. Humanity is ready for them, however, having been in preparations for almost a full year. A week of savage fighting will take place throughout the outer Sol System before the Kzinti are stopped at the Asteroid Belt. Most of the Kzinti ships are destroyed by a combination of asteroid based lasers and mass driver fire. A surprising number are also caught when the Sol System "beam rider" system is activated, catching and destroying them as if they were flies in a web. A fleet of UESF vessels led by a number of armed DY-500s, which had been laying in wait behind the asteroids, destroys most of the survivors. Only a handful of Kzinti ships escape the battle.
- The dual victories of humanity at Alpha Centauri and the Sol System mark the official end of the First Earth-Kzin War. The Kzinti will not be heard from again for another two years.
- The starliner *Enterprise* finally arrives at Alpha Centauri. By some miracle it has managed to avoid the Kzinti. The common answer given as to how is, "Space is a big place."
- The Terran gravitic distortion engine, better known as the "Firecracker drive," is first tested. It proves unworkable and is shelved. A positive side benefit of the program is the development of the inertial dampening system, which will become standard on all Terran (and Federation) vessels once it enters service.
- Zephram Cochrane's unmanned test drone exceeds the speed of light for 1.004 seconds by use of subspace field technology. His efforts represent mankind's first working warp drive. For this he will receive acclaim on his homeworld and the Nobel Prize – the first non-Terran ever to receive the honor. Despite the accolades he knows that the test did not go as planned and major problems still remain with warp drive. More work is needed in order to make it a practical reality.





- Unknown to all concerned, a Vulcan survey ship has quietly observed Cochrane's first successful warp drive demonstration. They are the only species in the Local Group that currently posses the secret of faster-than-light drive. Logic dictates to the Vulcans that they should initiate contact with humanity once a stable human-built warp drive is achieved.
- Cochrane is offered the chance to go to the Sol System aboard the returning *Icarus* to continue his warp drive research.

---

**Convergence point between the Prime One and Prime Two timelines (see Volume 3).**

---

## 2051

- The *Icarus* begins its return trip to Terra. They leave without Zephram Cochrane, who has decided to continue his warp drive research on his homeworld Alpha Centauri.
- All Terran colonization flights are put on hiatus due to the conflict with the Kzin. Human exploration of the stars, save for military excursions and isolated flights, will not resume on any great scale until the end of the Fourth Earth-Kzin War.
- Terran shipyards begin producing new spaceships of all sizes and classes in anticipation of the continuing war with the Kzinti.
- The rapid increase in the number of civilian and military cargo carriers and transports within the Sol System has a profound impact on the Sol System's war economy.
- Rail gun technology is developed by Terra and deployed on the next generation of UESF warships. Both single and dual railgun systems are backfitted onto older vessels and civilian craft whenever possible.

## 2052

- In view of the situation regarding the Kzinti, the scheduled retirement of the *Galileo* class transports is delayed "for the duration." Some will even continue in service for their owners (with first-generation warp drive upgrades) until the 2150s.
- The *Glenn* class space bus enters service.

## 2053

- On Alpha Centauri, theorist Zacmar Hodgkins publishes his thesis on the Law of Parallel Planetary Development. In brief, it states that similar lifeforms on similar worlds will develop similar cultures along similar timelines. This will later become known as Hodgkin's Law and will be proven time and again as mankind explores the universe around him.

- Colonel Green's War occurs as part of the Post Atomic Horror. This is another genocidal war carried out by Colonel Edward F. Green, who had escaped prosecution during World War III. Millions more will die on Terra as a result of his tactical nuclear strikes against the "impure peoples" of Asia before he is finally killed.
- The main laboratory at Kashishowa Research Station literally disappears from the surface of Luna on 08 August 2053, taking most of the station with it and leaving behind a perfectly smooth crater 18 meters in diameter. This event appears to have resulted from an overload due to a Terran warp drive experiment.
- Data gleaned from the Kashishowa Event provides Zephram Cochrane with the information he was missing to perfect his warp drive theory. The modified base equation for warp travel now includes a variable (known as Cochrane's Constant) that takes into account distortions in the local space-time continuum, such as the gravity of large stellar masses.



---

**According to Section 31 this marks a common convergence point among many of the various Prime and Mirror timelines. The track that the timeline will follow depends on whether or not Cochrane elects to inform the Terran-Centaurean military-industrial complex of his revised warp drive equation. Should he decline, then his "masters" will seize it from him by force in order to win the war and permanently divert the track into the realm of the alternate Mirror timelines.**

---

## 2054-2056

- The Second Earth-Kzin War

## 2054

- The *Icarus* returns from *Alpha Centauri*.
- The *Wayne* class scout enters service.
- The Kzinti return in force, attacking both the Sol System and Alpha Centauri simultaneously.
- The Second Battle of the Sol System. The Kzinti come in from below the plane of the ecliptic and attack all major Terran space colonies simultaneously. This is to keep them from sending reinforcements in their planned attack on Terra itself.
- The L-5 space station *Brynnar City* is hulled by attacking Kzinti craft during an intense space battle. Over 6000 colonists die within 20 seconds from depressurization and loss of atmosphere. The shattered space city will later be declared a total loss and scrapped for parts and materials.



- Particle beam weaponry is used by Terran forces for the first time at the Battle of the Line in defense of Terra itself. It proves devastatingly effective against the Kzinti, disrupting the graviton field of their ships and sending them spinning out of control. The Second Battle of the Solar System ends in victory for humanity. Never again will Terra come so close to conquest and occupation by the Kzinti.
- The Second Battle of Alpha Centauri ends in victory for the Kzinti. They overwhelm the fledgling Centaurean self-defense forces and occupy Alpha Centauri VII. The survivors flee to the hills or to deep ocean bases where the Kzinti will not follow. The Kzinti will control the Alpha Centaurean system for the next three years.
- Zephram Cochrane is among a number of Centaurean dignitaries and scientists inside the Terran starliner *Enterprise* in orbit. It manages to successfully run the Kzinti blockade of Alpha Centauri VII and escape to deep space. The ship will spend the next three years on the run until it is found and rescued by UESF forces. The fact that it has upgraded engines and improved weaponry, added during its stay at Alpha Centauri, has a lot to do with this. The presence of Cochrane and his technological genius is another factor.
- The attempted Kzinti attack on Terra brings about the end of the Post Atomic Horror within the decade. Mankind once again unites under the banner of the New United Nations against the Kzinti menace.
- Terran scientists working to reverse-engineer Kzinti technology from captured and damaged ships discover that their foes already have a crude form of warp drive. It is only capable of warp "bursts" over "short" distances and works off of stored energy from a spaceship's fusion power plant. It is quickly dubbed the "jump drive" by the Terrans. General Dietrich makes building a working Terran copy of the Kzinti "jump drive" one of the UESF's top project priorities.



## 2055

- "Spinner" drives are revived by the UESF as part of the research into CDP generator technology.
- The DY-550 class transport enters service.
- The UESP warp prototype ship WD-1 propels Rosy the chip at a speed of Warp 1.5 across the length of the Sol System. It is retrieved by the *UES Fisher* near the Pluto Test Range. It employs CDP generator technology as modified by reverse-engineering Kzinti "jump drive," plus refinements from Zephram Cochrane's latest warp drive research. Work commences immediately on CDP generator that

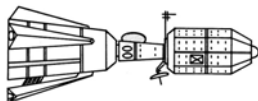

can be back-fitted onto ships with ion impulse and spiked antimatter drives.

- A Vulcan survey ship monitors this successful warp drive test. They transmit the information back to their homeworld for further analysis.
- The Vulcan Council rules that humanity is at last beginning to fulfill the promise it has shown. First contact will be withheld pending the final defeat of the Kzinti. Best estimates place the collapse of the Kzinti Empire as taking place with favorable odds of 2.635 to 1 within 10,827 years.

## 2056

- The *Keller* class space ambulance enters service. These have been developed in light of the massive casualties from the First and Second Battles of the Solar System. They are some of the fastest sub-light ships of their time, designed to quickly travel to and from battle zones in the war with the Kzinti.
- The UESF retires the last of its DY-500 series transports. One is converted into a memorial at the UESF Titan Base in honor of the fallen from the First Battle of the Solar System. Many will continue to fly on under civilian ownership for years (and even centuries) to come.
- The Kzinti halt their attacks on humanity for a time. Instead, they consolidate their position on Alpha Centauri and set up a forward base of operations on one of the planets of nearby Proxima Centuri. The cessation of Kzinti attacks in this year is generally regarded as the end of the Second Earth-Kzin War.
- The *Mahan* class heavy cruiser enters service. It is the first of the UESF's war-era warships. It is also the first to incorporate many hard-learned lessons in space battles against the Kzinti into its design.



## 2057

- A 100 Years In Space Poll conducted by the United News Services lists the top three achievements of the past century as the first man on Luna, the Venus Terraforming Project, and Zephram Cochrane's invention of warp drive. It also lists the ongoing Earth-Kzin Wars as being more of a threat to the future of mankind than had been the Third World War.
- The now-infamous UESPA Xenobiological Probability Study, overseen by Dr. Maurice Bertrand of the L-4 colony *New Paris*, "concludes beyond any shadow of doubt that the possibility of non-human life in the Universe is practically non-existent." When criticism is leveled against him with regards to the Kzinti, the good doctor points out, "They are but feline humanoids and in no way contradict this study."

- The legendary DY-X series assault cruiser enters service with the UESF. It will bear the brunt of the burden during the Third and Fourth Earth-Kzin wars and become a legend in its own time.

## 2058-2060

- The Third Earth-Kzin War



### 2058

- The Third Battle of the Solar System ends in a decisive defeat for Kzinti forces. The new ships, weaponry, and "jump drive" technology of the UESF is the telling factor in the fight.
- The *Liberty* class cruiser enters service.
- A new generation of orbital weapons platforms finish placement by the UESF around Terra, Luna, Mars, Asterpolis, and other key Sol System sites.
- For the first time since the beginning of the Earth-Kzin Wars humanity goes on the offensive, driving the Kzinti from their advance bases around the periphery of the Sol System. General Dietrich's first major goal is the liberation of Alpha Centauri. His second is to take the war to the Kzin themselves.
- Working under the banner of the Combined Forces, the UESF along with surviving Centaurean military forces use jump drive technology to travel to Alpha Centauri in less than a year. Their goal is to retake the system from the Kzinti.
- The *Enterprise* is located by the Combined Forces. They whisk Zephram Cochrane and the Centauri delegates to safety back on Terra as soon as possible.
- The Third Battle of Alpha Centauri begins.

### 2059

- On 21 August, at the end of a heavily fought campaign that lasted for 459 days, the Combined Forces retake Alpha Centauri VII. Kzinti commander Zrath-General, former governor of the occupied planet, elects to die in single combat with "Hardigan's Rangers" commander Major Susan Hardigan rather than be captured and held as a prisoner of war. 317,432 members of the Combined Forces campaign are killed and 742,385 wounded. 1,238,455 Kzinti are killed in the battle. Only 14 are successfully taken prisoner at the Kzinti base at Proxima Centauri, which was captured 74 days into



the campaign in a far less costly fight. Over 18.6 million Centaurean civilians have been slaughtered by the Kzinti by the time their homeworld is freed by the Combined Forces.

- The location of the Kzinti homeworld is gleaned from the databanks of the captured Kzinti base at Proxima Centauri.
- Conception of Operation Rock Drop. Its success will depend on the ability of Zephram Cochrane and other human scientists to make operational an unusual alien device recovered at Sidonia on Mars (Sol IV) back in 1987.
- The fleets of the Combined Forces embark on a "planet hopping" campaign towards Kzinti space. Their offensive eventually grinds to a halt near an unnamed rogue planetoid halfway to the Kzinti Empire's border.
- The Pluto Advanced Research Station opens as an adjunct of UESPA's Pluto Observation Post. It is the first new civilian space facility since the start of the Earth-Kzin Wars.
- The *Bathyscaphe* class ships are withdrawn from service.
- A UESF squadron in pursuit of fleeing Kzinti forces encounters a ship of the Vegan Tyranny for the first time. It inflicts heavy damage on them and forces them to withdraw, allowing the Kzinti to escape.



### 2060

- Operation Rock Drop is executed successfully. A large asteroid is sent to the Kzinti homeworld via a temporary wormhole. It smashes into the planet, killing Kzinti by the millions and laying waste to large areas of the planet. This action effectively ends the Third Earth-Kzin War.
- The Industrial Space Ark concept is proposed.
- The last of the *Saratoga* class cargo carriers are withdrawn from service.
- The *UES Bonaventure* becomes humanity's first true warp drive starship. CDP generator "jump drive" technology becomes obsolete overnight.
- The *Bonaventure*'s first flight is to return Zephram Cochrane and the Centaurean government-in-exile home amid a joyous celebration.

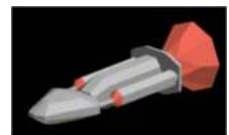

- A UESF intelligence gathering team following up on reports in the captured Kzinti archives rediscovers a “lost” Centaurean space colony on the second planet in the system.
- The *Long* class transport barge enters service.

## 2061

- A special flight is chartered by Solar Spaceways for the viewing of Halley’s Comet as it makes its regular 78-year pass through the Sol System. The comet finally breaks up as it makes its pass around Sol, bringing to an end one of the wonders of the Terran skies for generations.
- In light of its increased importance during the Earth-Kzin Wars the UESF is formally recognized as an independent organization in its own right. Also, at this time, and in acknowledgement of recent events, its name is changed from United Earth Solar Fleet to United Earth Star Fleet. UESPA remains the Sol System’s chief instrument of space science survey and exploration; however, its importance will wane and gradually fade over time as that of Star Fleet rises.
- The Martian Revolution occurs (December).

## 2062

- The Fundamental Declarations of the Martial Colonies are issued. This will eventually be considered one of the most important and historic documents in known space history.
- After long years of faithful service in the Venus Terraforming Project, the *Venus Flyer* is finally retired.
- The *Orion* class scout enters service. This is nothing but a scaled down *Liberty* class with a smaller crew.

## 2063-2065

- The Fourth Earth-Kzin War



## 2063

- A formal Terran-Centaurean Cultural Exchange program begins in January. One of the side benefits of this program is that it helps bring a number of Terran activists to Alpha Centauri VII, who then help the Centaureans rebuild their world from the effects of the Kzinti occupation.
- The CDP-refitted *Icarus*, along with a UESF escort, becomes the first human starship to reach Barnard’s Star (August). There it finds both the remains of its sister ship *Adam & Eve* and a major Kzinti supply base. The Terran ships are forced to defend themselves, destroying several Kzinti ships before withdrawing

from the area. This incident starts the Fourth (and final) Earth-Kzin War.

- The Kzinti, infuriated by the death and destruction on their homeworld and this most recent incursion by “the softskins,” commence a series of hit-and-run attacks against any human ships, armed or unarmed, that they can find. They are now too weak in strength to both hold onto their empire and mount a major offensive at the same time. This undeclared “shadow war” will last for just under five months before the patience of the UESF finally wears out.

## 2064

- The *Franklin* series of probes enters service.
- The *Verne* class survey cruisers enter service.
- Construction begins on a new series of survey cruisers in the first-ever joint Terran-Centaurean starship construction project. The design for the *Keldysh* class shows the influence of the newly formed Cochrane Warp Dynamics. It is the first major human starship class with boom-mounted warp engines.
- The Combined Forces mount their second major offensive against the Kzinti. This time they warp directly to the borders of the Kzinti Empire and begin systematically destroying every base, ground installation, and fleet they come across. Kzinti forces are no match for these new warp drive ships and they take heavy losses. In the space of seven months the Combined Forces wrest the rimward sectors of the empire from Kzinti control, freeing its long-enslaved systems. General Dietrich’s next planned move will be to work his way toward and eventually conquer the Kzinti home systems.
- Swallowing his pride and in order to ensure the continued existence of his people, the Kzinti Patriarch sends an envoy to General Dietrich’s fleet requesting a parley to negotiate terms of surrender. The Fourth Earth-Kzin War is over.

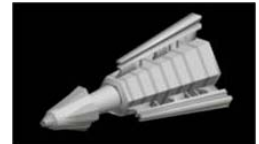

## 2065

- The terms of the Treaty of Sirius are imposed on the Kzinti. They are stripped of their empire and confined to a sphere 50 light-years in diameter centered on their homeworld of Kzin. They are forbidden combat-capable spacecraft larger than police cruisers, as well as advanced warp drive and weapons technology. Aside from the occasional “incident,” the treaty will for the most part be honored. Humanity will not fight a war with the Kzinti again for the next two centuries.





UESF "Bolo" recon craft (2050)

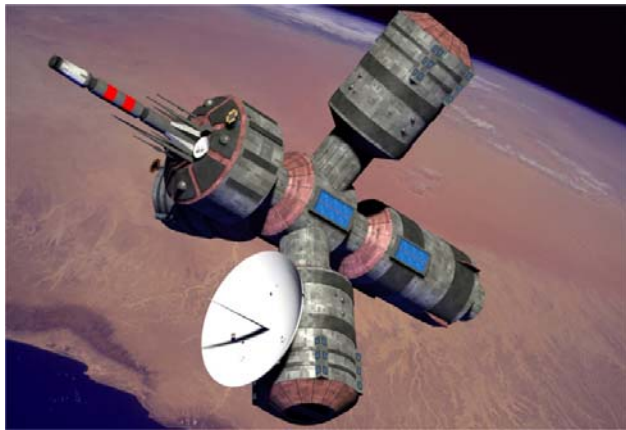

UESF orbital particle beam cannon (2052)



UESF DY-X squadron (2059)

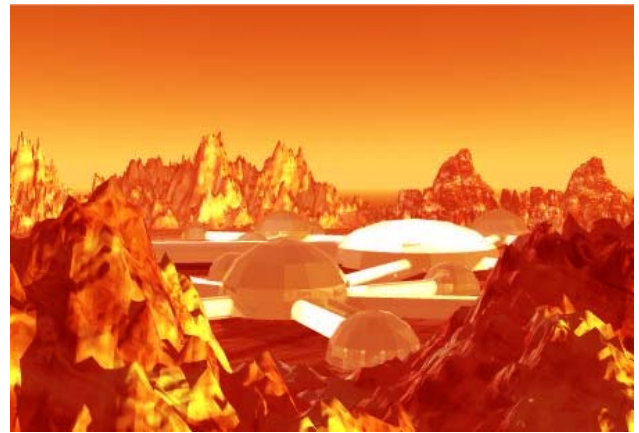

Kzinti advance base on Proxima Centauri (c.2055)



UESF Fleet Operations Center, Sidonia Base, Mars (2058)



Operation Rock Drop, Kzinti perspective (2060)



UESF Marine surface recon (2063)







# DY-X SERIES ASSAULT CRUISER

**SERVICE ENTRY DATE (OLD CALENDAR): 2057**

Around the same time that the *Mahan* project got underway the firm of Dyson-Yoyodyne proposed a combat design based on their proven DY-series technology. This would be able to fill both the space combat and ground assault roles. The UESF, which was desperate for anything that could be used to fight the Kzinti, quickly approved the project. The armored DY-X assault cruiser entered service just in time for the Third Earth-Kzin War (2058-2060). Its unique design allowed it to operate in theaters and under conditions that were unsuitable for a *Mahan* class heavy cruiser or other UESF "heavy." The design proved so versatile that it remained in the UESF inventory, with minor upgrades and improvements, until the UESF was formally dissolved in the 22<sup>nd</sup> century. Many still remain in service with their civilian owners as of this date. Two different second-generation DY-X designs were planned but never built.

Although Dyson-Yoyodyne no longer makes the DY-X it still supplies parts and service to their many owners. Kloratis Drive Systems of Tellar offers a full warp drive upgrade using its reproduction Pegasys VX-28, non-dilithium moderated warp engines. This gives any suitably modified DY-X a cruising speed of Warp 4 and a maximum speed of Warp 5.5.

## SPECIFICATIONS:

Length: ..... ? m  
Beam: ..... ? m  
Draft: ..... ? m  
Mass: ..... ? DWT  
Crew ..... 85  
Range: ..... ? c  
Maximum speed: ..... x  
Number of small craft: ..... 2  
Armament: ..... 4 forward lasers  
Dual bay hard points (12-pack missile racks common)  
2 wingtip particle cannons (Fourth Earth-Kzin War)

### Innovations:

- First production Terran starship with a CDP generator
- First DY-series designed for planetary landings

## VISUAL:

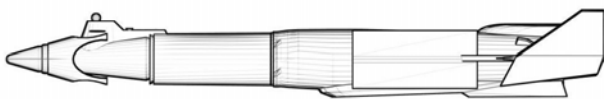

DERIVED FROM THE *LEIF ERICSSON* CONCEPT BY WALTER M. JEFFRIES  
AS REDRAWN BY WINCHELL CHUNG



DY-X concept painting (2052)

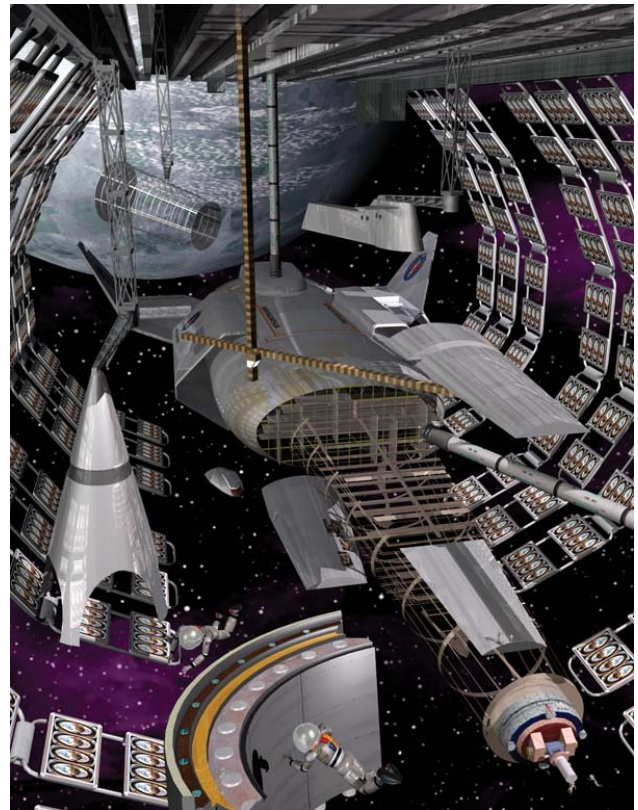

The first DY-X under construction (2055)



Upgraded DY-X (c.2075)



## VERNE CLASS SURVEY CRUISER

**SERVICE ENTRY DATE (OLD CALENDAR): 2064**

The *Verne* class survey cruisers were widely regarded as the most innovative and visually stunning of Terra's first generation of warp drive starships. Originally based on a wartime United Americas design, their unique design and proven reliability were admired by would-be starship engineers across the Sol System. They were the first to mount triple external warp engines (feeding into a common thrust system). Although built too late for the Earth-Kzin Wars, the class starship *UES Verne* ferried Sol System representatives to the Sirius star system for the signing ceremony of the Treaty of Sirius. The *Verne* class starship *UES Amity* is officially recognized as making first contact with the Vulcans after the end of the Earth-Kzin Wars. A total of 18 were built, all of which were retired by 2095.

### SPECIFICATIONS:

Length: ..... 235.9 m  
Beam: ..... 80.4 m  
Draft: ..... 50.0 m  
Mass: ..... 25,000 DWT  
Crew ..... 112  
Range: ..... 5 years at L.Y.V.  
Cruising speed: ..... Warp 2.5  
Maximum safe speed: ..... Warp 2.7  
Armament: ..... 8 forward lasers  
50 fusion missiles

Innovations:

- First starship with triple warp drive nacelles

### VISUAL:

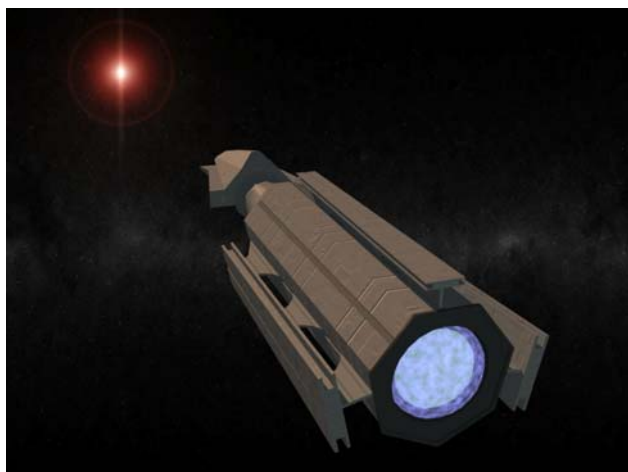

*AMITY* DESIGN BY RICH STERNBACH  
IMAGE COURTESY OF THE SPACEART ARCHIVES

## KELDYSH CLASS EXPLORER

**SERVICE ENTRY DATE (OLD CALENDAR): 2064**

The *Keldysh* class survey cruiser was Zephram Cochrane's first major peacetime starship design to be built. Based on a never-built Terran wartime design, the intent was for these ships to undertake the first surveys for UESPA of the holdings of the former Kzinti empire beyond Local Group space. They performed admirably in this role despite their rather ungainly looking design. One unique design feature, though, overlooked at the time, were their boom-mounted circumferential warp engines. This arrangement was taken directly from Cochrane's own warp drive prototype. This would prove to be the herald of things to come. The class remained in service, with periodic upgrades and swapping of old engines for new, until 2130.

The most notable member of the class, the *S.S. Valiant*, was lost in the upper quadrants of known space near the edge of the galaxy. It had been following the projected route of the Terran spaceship *Courageous*, lost almost four decades earlier, in an effort to determine what had happened to the ship and its crew. The ultimate fate of the *Valiant* would remain a mystery until its recorder-marker was found by the starship *Enterprise* in 2261.

### SPECIFICATIONS:

Length: ..... 97 m  
Beam: ..... 38 m  
Draft: ..... 19 m  
Mass: ..... 6,800 DWT  
Crew ..... 80  
Range: ..... 5 years at L.Y.V.  
Cruising speed: ..... Warp 2.05  
Maximum safe speed: ..... Warp 2.10  
Armament: ..... 2 laser cannon  
8 fusion missiles

Innovations:

- First major peacetime starship class since the end of the Earth-Kzin Wars
- First starship with twin boom warp drive arrangement

### VISUAL:

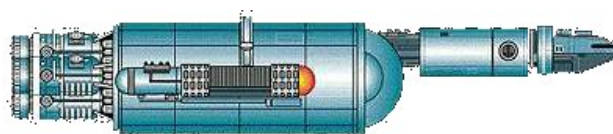

*S.S. VALIANT* CONCEPT BY GREG JEIN AND MIKE OKUDA  
SCHEMATIC COURTESY OF THE DAYSTROM TECHNICAL INSTITUTE



# ALIEN ENCOUNTERS

## THE KZINTI

The Kzinti (*home felis kzinti*) are a race of aggressive and warlike feline humanoids that at one time dominated most of the Local Group systems and beyond. They and the Caitians bear more than a passing likeness and many have suggested a common ancestry, although both species will vehemently deny this. Kzinti are the larger and stronger of the two, with pronounced claws and tiger-like rugged features. Kzinti strength is comparable to other humanoids from high-gravity planets, such as Vulcans and Klingons, but they are the stronger due to larger frames and heavier musculature. The most obvious visual difference between Kzinti and Caitians is their ears. Caitian ears are more like those of a regular cat, while Kzinti ears are bifurcated, with sharp spines instead of the Caitian felinoid smooth taper.

As with all felinoids the Kzinti language is a series of hisses, purrs, catcalls, and body motions. The *Heroes-Tongue* is one of the most difficult felinoid languages to master and even students with years of experience usually never get beyond a conversational level. On the other hand Kzinti take to other languages very well, although they tend to rasp and growl when they speak.

Kzinti culture is simple. Their society is organized among strictly patriarchal lines, lead by their chief Patriarch (*Highest-of-Kzin*). Kzinti families/houses are called *prides*, with the most aggressive male (*kzin*) being their leader. Kzinti females (*kzinretti*) have been bred down into semi-intelligent subservience over millennia, although there have been a few notable exceptions – or abominable mutations, from the Kzinti point-of-view. There are only three choices for the rare intelligent *kzinretti*: death, exile (if she is lucky), or pretend to be dumb for the rest of her life. Each young *kzinretti* in the pride is expected to bear multiple litters for the pride leader, thus ensuring the continuance of his line. Kzinti young are always born live with at least one male and one female in each litter.

The Kzinti are aggressive and warlike to the point of being accused as barbarians by other cultures. To the Kzinti their lifestyle is as natural as could be. They relish the hunt and its spoils as much as a Tellarite loves to argue, no matter what the reason or cause (for both cultures). They also are quick to “adapt” (read *steal*) whatever technology they can lay their hands on in order to further themselves. They stole the capability of spaceflight from peaceful visitors to their world in ages past and they stole the secret of FTL travel from the Tellarites during their initial conquest of Tellar Prime. Most recently they have tried to steal the secrets of the long-dead Slaver Empire in order to rebuild their own.

Kzinti are strictly carnivorous. They prefer their food “live” and have been known to eat prisoners of war and even their own when sufficiently aroused. They despise vegetarians and consider them of little worth, rarely if ever speaking to them.

The Kzinti attitude of ingrained superiority tends to color their reaction to other cultures and species. Females are universally treated as second-class citizens (as are *kzinretti*), even those of intelligence. They despise Vulcans, partly due to their technological superiority but largely because of their pacifist culture and vegetarian diet. Only those races who have fought them, held their own in battle, and not succumbed to “following the *eaters-of-roots-and-leaves* (Vulcans)” are treated with grudging respect. Among those on this Kzinti short list are humans, Andorians, and Klingons.

### Asides

1) Two Terran slang words that the Kzinti find highly offensive are *ratcats* and *tabbies*. These were coined by Terran fighters as derogatory terms during the Earth-Kzin Wars.

2) It is common when meeting or being introduced to a Kzinti in a formal setting for him to snarl at you in greeting. The proper response is for the lead male present in your party to return the snarl as loudly and fiercely as possible. Any females present should not speak unless their presence is first acknowledged by the Kzinti.



The Kzinti Patriarch (2065)



# HISTORICAL ARTICLES

## KASHISHOWA STATION MISSING

UNS NEWSWIRE – 08 AUGUST 2053



Kashishowa Station, Luna's premier warp drive research facility, has literally vanished from the surface of the moon. Only an 18-meter diameter, perfectly hemispherical crater remains where the station once stood. All of its personnel are feared dead and efforts are being made to contact their families and next-of-kin.

Kashishowa Station was established by a grant from Brack Interplanetary in 2043 as a place for advanced space science research. It began studies in Zephram Cochrane's warp drive theory in 2050 with assistance from the nearby Farside Moonbase. Its latest project involved research into CDP generators, a type of technology that would allow a starship to travel at faster-than-light speed for a short time using existing fusion reactors as a power source. UNS space expert Ramsey Allen believes the cause of the station's disappearance might be linked to the catastrophic failure of a CDP test.

You're trying to generate a subspace warp field around a starship so that it can move faster than light. That works like the outer hull on a submarine, enclosing the actual "boat" inside so it can withstand the pressure the ocean when it dives. What probably happened is that the energy converter assembly failed during a live test. That would have cause the field to suddenly expand and then contract to nothing in a split second, taking everything inside with it. There's nothing there because there's nothing left to *be* there. It's just gone, and we'll never see it again.

Both UESPA and the UESF have refused to comment on the disappearance of Kashishowa Station so far. A full press briefing is promised shortly.

## BRYNNER CITY DESTROYED BY KZINTI

EXCERPTED FROM THE ABS EVENING NEWS  
WITH MITCH McCONNELL – 4 JULY 2054



Good evening. What you are about to see is not very pretty. If you have small children in the room, you might want to take them away or cover their eyes.

(pause)

These are some of final images from the L-5 *Brynner City* space colony after it fell victim to the Kzinti attack mere hours ago. This sequence lasts only 20 seconds and was recorded from a stationary ABS camera that happened to be filming at the time. Our own cameraman, Doug Riddick, was present when this sequence took place.

*RIDDICK:* The station is taking a tremendous pounding, Mitch. All the civilians are leaving for the shelters. We were caught completely off—oh, my GOOO---

(wind howling ... dust, debris and bodies flying everywhere, mainly upward right ... millions of pieces on screen ... camera takes a hit, goes to static)

Doug Riddick, along with over 6000 of the inhabitants of Brynner City, died in those 20 seconds. Our condolences to Doug's family and the families of those who were living in Brynner City. Only 158 people, mostly city staff and service personnel in the control and utility sections, are known to have survived.

# ALPHA CENTAURI BELONGS TO KZIN

OFFICIAL PROCLAMATION – 6 JULY 2054



ATTENTION HUMANS OF ALPHA CENTAURI

You belong to us now. We took your world. We broke your ships. We slaughtered your warriors by the score until no more were left to fight. Have no hope in the few that escaped. We will find them and feast on them at our dinner tables. You too we will feast on if you do not cooperate. Those who serve us will live. Those who do not will die. Those are your only choices. Resistance is useless. All praise to the Great-Fanged-One and the mighty Claw-Swipe of Kzin.

Zrath-General  
Military Governor  
Alpha Centauri

# COCHRANE AND *ENTERPRISE* M.I.A.

UNS NEWSWIRE – 7 JULY 2054



In a related story, no word has been heard from the starliner *Enterprise* since its flight from Alpha Centauri three days ago. The veteran starliner, one of the first Earth ships to visit Alpha Centauri managed to escape the Kzinti fleet blockading the system and escape into deep space. Its last message was relayed via microburst through the Proxima geon hole as it passed by at top speed. It reported that it was being pursued by Kzinti cruisers and would attempt to evade them for as long as it could. It also reported that it was carrying the major leaders of the Centaurean government and its top scientists, including warp drive pioneer Zephram Cochrane. The UESF has given the search for the *Enterprise* its highest priority due to Cochrane's presence on board. The *Enterprise* had only recently been refitted with new engines and weaponry due to the first Kzinti attack on Alpha Centauri, making it the fastest ringship in known space. It is hoped that the ship's new systems plus ample provisions will help it to hold out until a UESF fleet can come to its rescue.

# ALPHA CENTAURI LIBERATED

UNS NEWSWIRE – 21 AUGUST 2059



Today, in an official ceremony presided over by Combined Forces General Hans Dietrich, victory was proclaimed in the fight to liberate Alpha Centauri. The campaign was the longest to date in the history of the UESF, lasting 459 days. Sporadic fighting is still going on in remote areas of the planet; however, all major sectors have been secured from Kzinti occupation. General Dietrich thanked his troops for their dedication and valor, and then handed out numerous awards for valor in combat.

Among those receiving the Solar Medal from General Dietrich at today's ceremonies was Major Susan Hardigan, commander of the famed "Hardigan's Rangers" covert operations unit which has earned quite a reputation during the Earth-Kzin Wars. It was Hardigan's unit that drove former Kzinti occupation governor Zrath-General to ground and prevented his escape from Alpha Centauri. Hardigan then offered Zrath-General the choices of surrender or certain death. Zrath-General chose "the lesser of two evils" and attacked Hardigan's team, killing or critically injuring everyone but her. He was in turn killed by Major Hardigan in single combat. Her duel with the Kzinti warrior, who was four times her size and by far the stronger of the two, is sure to go down in the legends of the Star Fleet Marines. Hardigan was injured during the fight; however, she managed to get back on her feet in time for the awards ceremony. She is expected to make a full recovery.

The casualty figures from the fight to liberate Alpha Centauri are staggering. Some 310,000 members of the Combined Forces were killed and over 720,000 were wounded. When asked to comment, General Dietrich curtly replied that it was a small price to pay for the freedom of humanity. When pressed if he would do it again, he replied, "Why, of course. Wouldn't you? What kind of a stupid question is that?" Dietrich then barred the press from any more "badgering" of UESF personnel.

# STAR FLEET OFFENSIVE STALLS

MBS NEWS MINUTE – 16 DECEMBER 2059



*Mahan* class cruiser stalking its prey (2064)

In the latest news from the war front, Star Fleet's offensive against the Kzinti appears to have stalled halfway to its goal. Kzinti forces are putting up a tremendous fight along a line that appears to be halfway to the border of their Empire. Eight Star Fleet destroyers and six cruisers were damaged or destroyed in engagements with the Kzinti within the past five days. Star Fleet forces are holding their own, however, and reinforcements are on the way.



# THE ROCK IS DROPPED

EXCERPTED FROM THE HISTORICAL NOVEL *THE PATH TO KZIN*  
BY BERNARD BRAGEN (TERRA: COKEBURY PRESS LTD, 2075)



Major General Hans Dietrich aboard his flagship, the heavy cruiser *Indomitable* -- Operation Rock Drop (2060)

"I need a little more time, General!"

The ship rocked and noisy static cut through the display. "I'm doing my best, Doctor!" Dietrich snapped.

"Right. Sorry." The image nodded, then winked out. The man in the black leather coat dashed back to the sparking console and began making more adjustments. "Just another minute, old girl!" he yelled at the machine. "Come on! Don't let me down now! You can do it!" Suddenly he hit the side of the console with his closed fist. It roared to life with a strange metallic siding sound. A bizarre form of energy began to dance along the power cables leading out from under the console, through the door, and to the alien device outside. The man's eyes lit up at once.

"Fantastic!"

In the area of space just off the port beam of the *Indomitable* an angry maw of nothing began to open. Two Kzinti ships were ripped apart almost immediately by the expanding edges of the vortex. The others flew out of the way, not wishing to suffer a similar fate. Aboard the battered *Indomitable*, General Dietrich wasted no time. He slammed his fist onto his comm Panel.

"Now, Carothers!"

The fusion engines on the back of the asteroid roared to life. Slowly, inexorably, it began to move towards the hole in space. Second by second, minute by minute it continued to gain momentum.

Dietrich and his crew didn't have time to watch. A perimeter alarm sounded. "Kzinti cruiser port beam, six-o'clock, firing missiles!"

"Return fire!" Dietrich bellowed.

Two of the Star Fleet cruiser's massive rail guns swung around and tore into the oncoming missiles. One hit on one was enough. A wave of explosions rippled across space as the concussion set off most of the rest.

"Sir! Three got through!"

"Brace for impact!"

Down below, the Doctor had just pulled the last of the power cables loose when he heard the collision klaxon go off. He instantly dived for the door to the blue box in one corner of the lab. Almost at the same moment a tremendous explosion tore through the area. Papers and equipment went everywhere as what was left of the compartment depressurized. The Doctor hung on to the door frame for dear life, slowly but surely pulling himself inside. He made it, clothes still smoking, then staggered to his feet and hit a switch on the console. The doors shut. He looked up, still gasping for breath. For a split second on the overhead screen he could see the asteroid as it flew into the shrinking wormhole and disappeared. Then the room spun wildly in every conceivable direction. He just managed to throw another lever on the console before he was flung into a bulkhead and knocked out.

The strange metal scraping sound filled the room. Outside, in the debris-filled vacuum of space, a tumbling box with a flashing light faded and disappeared from sight.

"Report!"

The *Indomitable* shook from yet another hit. Murgison had to yell to be heard above the noise and alarms. "Hull breach, lab section – generator room!"

"Dear God," Dietrich groaned.

---

Kzinti records tell of the day when the Great-Fanged-One grew angry with them and unleashed the Deathbringer onto their world. He roared and a hole opened in the sky above Homeworld. From it the Deathbringer fell, striking the edge of the Northern-Water with the force of a thousand Bright-Lights, with screaming-air and fire-winds that devoured millions of *kzin* and their *prides* in its way. The land was turned to ash, the waters boiled away, and the sun was darkened for almost two spans of the seasons. They had not done enough, they told themselves. They had not upheld the pride of the Kzin and fought as warriors should. So they made their sacrifices to the Great-Fanged-One and he told them what to do. Human blood WOULD spill for this; however, Homeworld had to be saved first. After that ... yes ... after that, it would be the human's turn.

# HALLEY'S COMET BREAKS UP

UNS NEWSWIRE – 6 AUGUST 2061



Halley's Comet (archive photo)

Say goodbye to Halley's Comet. This longtime familiar visitor to the Solar System broke into seven pieces after making its pass around the Sun. The spectacular sight was witnessed by the passengers and crew of the spaceliners *Magellan* and *John Cabot*, which had been chartered to follow Halley's Comet as it made its regular 76-year swing through the Solar System. Scientists as yet have no answer as to why the comet broke up; however, instabilities within its ever-shrinking icy rock core as it was warmed by the Sun are the most probable cause.

Halley's Comet was named for English astronomer Sir Edmund Halley. It was he who first reasoned that comet sightings made in 1531, 1607, and 1682 all belonged to the same comet, and he accurately predicted its return in 1757. Its most spectacular appearance was its 1911 flyby, when it was brighter than any other object in the night sky. At that time it caused panic in many parts of the world and people feared that they they would be killed by poison gas coming from its oversized tail. Halley's Comet last returned in 1986, its trip shortened a bit when it passed by both Jupiter and Saturn. It was not as bright at that time and could barely be seen, but it was visited by no less than four different space probes during that visit. To date Halley's Comet remains the most studied of all Solar System comets.

A motion has already been filed with the International Astronomical Union to rename Halley's Comet in light of its breakup. The favored name for the new phenomena is the Halley Swarm. And, while Halley's Comet won't be gracing Earth's skies again, count on your children seeing the Halley meteor shower once the next 76 years rolls around.

# MARS DECLARES INDEPENDENCE

MBS EVENING NEWS – 13 MAY 2062



Today, in a special proclamation by Martian governor John Hammerlich, the rights of all inhabitants in the Martian Colonies and any other residents of Mars to be independent of any political or governmental interference from Earth were assured. The governor's office has issued the Fundamental Declaration of the Martian Colonies, declaring independence from Terran control and asserting that the Martian Colonies are a free and sovereign body in their own right, with the same rights and powers as the New United Nations of Terra. While Governor Hammerlich has made no direct moves against the Terran presence on Mars, his Martian Militia along with former Consortium forces have stationed themselves within range of the UESF base at Sidonia. A message has been sent to General "Hammerin' Harry" Williamson, the base commander and a Kzinti war veteran, politely asking that his troops withdraw from Mars. General Williamson has thus far refused pending orders from his superiors back on Terra.

*It should be noted that cooler heads at the New United Nations managed to prevail over the war hawks demanding a military crackdown of the "Martian Revolt." In a public statement issued two days later, New UN Secretary General N'dengi Sulimari formally recognized the independence of Mars and ordered General Williamson to start preparing a withdrawal. He then successfully negotiated a treaty with the newly independent Mars allowing UESF forces to remain, helping to provide protection against a potential Kzinti sneak attack while training and building the new Martian Army. New trade and exchange agreements with Mars negotiated in parallel helped to alleviate many of the problems that had caused the "Martian Revolt" in the first place. The quick thinking of Sulimari help nip this crisis in the bud and allowed the Sol System to remain united against the threat of the Kzinti. As for Mars, it gained its independence, became the first former Terran space colony to be recognized as an independent political entity in its own right.*

# WARP DRIVE BECOMES REALITY

ABS EVENING NEWS WITH MITCH McCONNELL – 1 AUGUST 2060



What you are about to see, folks, is only going to last for a split second.

(video rolls)

Did you spot it? Let's play that again but slow it down this time so you can see it.

(video rolls, frame by frame, stops on a blurred image)

That is the *UES Bonaventure* passing the UESF cruiser *Timonshenko* as she builds up speed for her first warp drive run, which was a complete success. Today the *Bonaventure* became the first starship to ever pass and maintain a speed faster than the speed of light. Reporter Lindsay Fuller was on sight at the Pluto Test Range for this historic occasion.

**FULLER:** Thank you, Mitch. With me is warp drive inventor Zephram Cochrane of Alpha Centauri, the man responsible for this remarkable achievement. Mr. Cochrane, how do you feel right now?

**COCHRANE:** Kinda giddy. Excited, happy – you name it.

**FULLER:** You've waited a long time for this, haven't you

**COCHRANE:** All my life.

**FULLER:** It's going to make a big difference in the war, isn't it?

**COCHRANE:** Well, I'm not a military man. I try to stay out of their business and they mine.

**FULLER:** But this is going to make their jump drives obsolete, isn't it?

**COCHRANE:** That was an inferior kludge, something they had to have because I wasn't here to do it right. *This* (points to the ship behind him) is the way it should be ... it *will* be. You just wait and see.

# THE WAR IS OVER!

ABS EVENING NEWS WITH MITCH McCONNELL

23 DECEMBER 2065

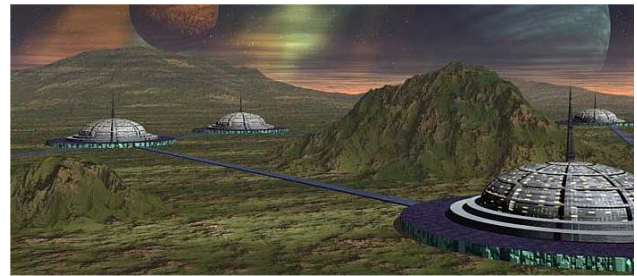

Good evening. As we prepare to celebrate the holiday season, from far beyond the stars comes news that will make this year's Christmas even more bright. The war is over. The Kzinti have surrendered.

(cut to UESF press briefing room, General Dietrich smiling, surrounded by reporters, mikes waving, cameras flashing, etc.)

Yesterday we received communications from Kzinti forces that their ruler, whose title translates as Patriarch, had ordered them to stand down. Today the Patriarch's ship approached our fleet and asked permission for him to come aboard. He came alone – a very proud being, very imposing. He asked for me, and once I arrived, he bowed and asked for terms of surrender.

The Patriarch stated that the Kzinti no longer had the strength to fight the war and continuing to do so would be a foolish and useless gesture, a "death without honor" in his own words. The terms were simple enough: all Kzinti ships would stand down and return to their homeworld, and Star Fleet forces would be allowed unhindered access to Kzinti space so long as they did not land on Kzin. General Dietrich asked and was granted permission for his fleet to accompany the Patriarch's ship back to Kzin and remain in orbit to enforce the surrender. The Patriarch agreed. Finally, per the last term of the surrender, human and Kzinti delegates will be meeting shortly at the neutral planet of Sirius IX to formalize a treaty ending Kzinti dominion of known space.

Folks, I don't know about you, but this is the best Christmas present I could possibly think of this year. It's over. It's finally over. No more people are going to die in this bloody and senseless war. It's over. We've won. The Kzinti Empire is no more. Merry Christmas, and God bless you, everyone. Thank you, General Dietrich and the Star Fleet. Thank you, Zephram Cochrane. Thank you, Centaurean Defense Force. Thank you, Star Fleet Marines, Hardigan's Rangers, Skull Squadron, the Flying Vikings, the Legion of Apollos and many, many more. It's over, thank God. It's really, finally over.



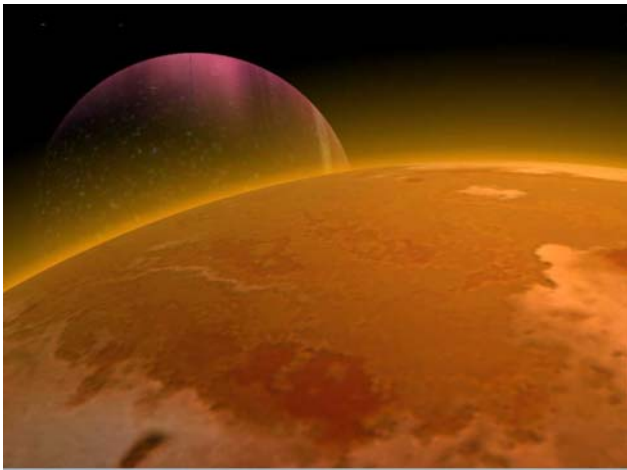

Proxima Centauri



Farside Moonbase (c.2050)

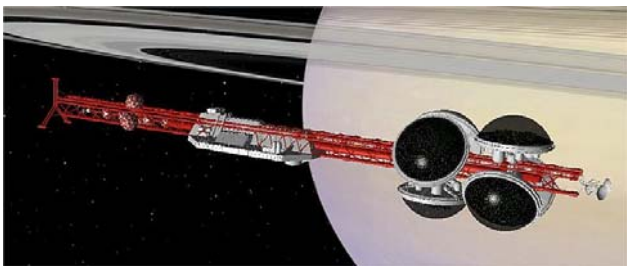

Terran agrosip (c. 2055)



Second generation DY-X concept painting (2065)

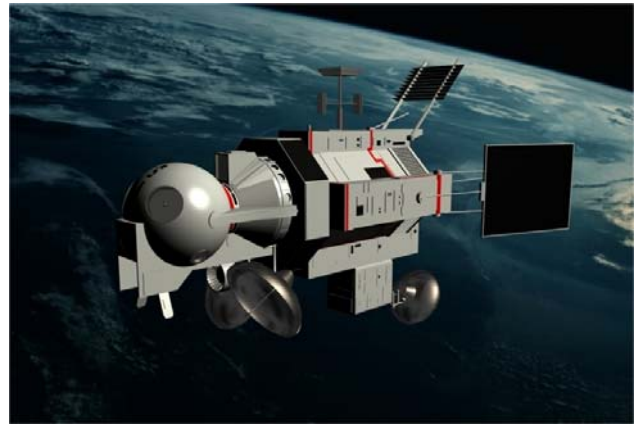

UESF deep space monitor (c.2055)



Marine night landing on Alpha Centauri (2058)



UESF Marines in combat – Operation Heavy Hammer (2059)



"7 Tango 7" –Hardigan's Rangers transport ship (c.2060)





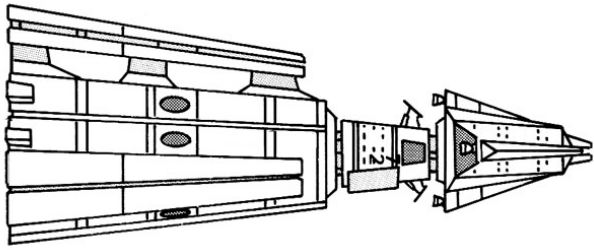

**VERNE CLASS SURVEY CRUISER**  
(20xx)

Length: 236 m                      Drive: first-generation warp drive  
 Mass: 25,000 DWT                Range: interstellar  
 Armament: lasers, missiles      Crew: 112

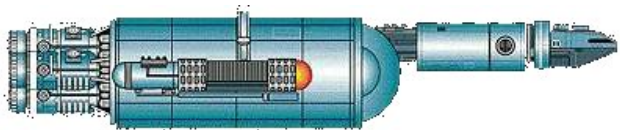

**KELDYSH CLASS SURVEY CRUISER**  
(2067)

Length: 97 m                        Drive: first-generation warp drive  
 Mass: 6,800 DWT                 Range: interstellar  
 Armament: lasers, missiles      Crew: 80



UESF interceptors on attack run  
 Second Battle of the Sol System (2054)

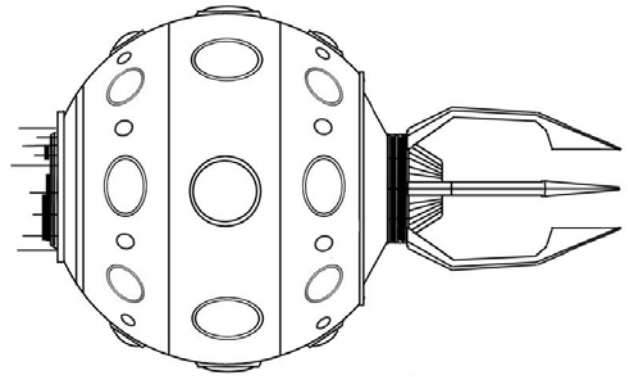

DESIGN CONCEPT BY PAUL LLOYD

**KZINTI PATROL CRUISER**  
(first sighted 2048)

Length: 248 m                      Drive: jump drive  
 Mass: 16,500 DWT                Range: interstellar  
 Armament: none                    Crew: 65

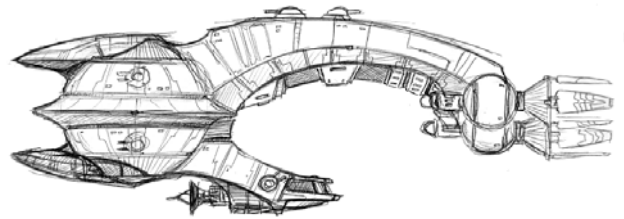

DESIGN CONCEPT BY ATOLM

**KZINTI ADVANCED DESTROYER**  
(first sighted 2058)

Length: x m                         Drive: jump drive  
 Mass: x DWT                        Range: interstellar  
 Armament: lasers, drones      Crew: 40

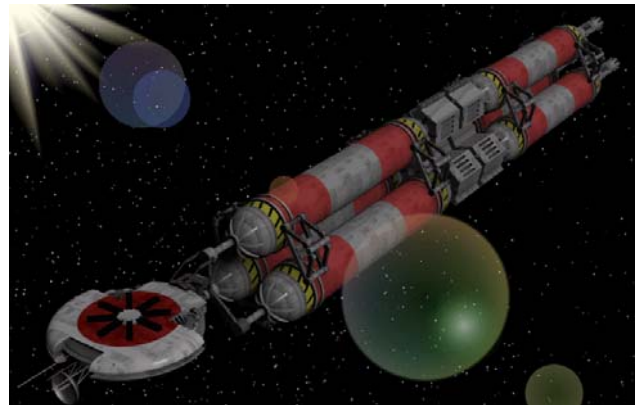

Terran long range transport (c.2060)

**to be continued ...**

# ACKNOWLEDGEMENTS

## VOLUME 04: 2049-2065

### AUTHOR'S COMMENTS:

This issue marks something of a watershed event in the *TREK* universe. For the first time, in any publication (official or fandom), an attempt is being made to reconcile the Four Earth-Kzin Wars that Sulu mentions in "The Slaver Weapon" within the *TREK* timeline. Others had looked at key parts of it before I came along, most notably Alan Dean Foster, Ally N. Gibson, James Dixon, Neal and Jana Hallford, and Jimmy Diggs. Dixon's unified *TREK* fandom timeline was a constant and necessary companion in my research. Gibson's essay in particular, on the chronological reconciliation of the Earth-Kzin Wars within *TREK*, proved to be the most helpful – although his dates and subsequent reasoning are marred by the use of the Okuda chronology (Prime Two). They have been corrected for this document. Russell Martin's research into the Known Space timeline for the Man-Kzin Wars was also quite helpful. Aridas Sophia (*Federation Reference Series*) and the guys over at the FRS Forums were great sounding boards as I tried to resolve various issues and aspects of this period in the history of the *TREK* universe. Finally, it goes without saying that award-winning sci-fi author Larry Niven himself deserves credit for "lending" the *TREK* universe one of its most memorable aliens species of all time, despite their sole episodic appearance to date.

It soon became obvious to me that the *TREK* version of the Man-Kzin Wars could in no way be reconciled with the events as they take place in Known Space. The most obvious difference is the amount of time in which each takes place. Reconciling Gibson's initial research with Dixon's yields a Prime One window of 2058-2065 for the Earth-Kzin Wars (from initial first contact to the signing of the Treaty of Sirius). The same rough order of events plays out over *two centuries* in the Known Space universe (2360-2584); plus that has two additional wars not referenced in the *TREK* universe. The same rough sequence of events, with appropriate adjustments for "known" *TREK* events, could be followed; however, the timeline was going to have to be seriously dilated. This meant that *some form of faster-than-light technology, with both ships and communications, was in use during TREK's Earth-Kzin Wars*. The communications aspect was easy enough. Both the old SFC and Dixon mentioned the discovery of "geon holes," though which FTL radio communications could be made (after a fashion) prior to the invention of subspace radio. The FTL starship issue, though, was another matter altogether.

It has long been established in every iteration of the *TREK* universe that Zephram Cochrane invented warp drive sometime around the beginning of the 21<sup>st</sup> century. The date is usually

2050 (Prime One), or 2063 (Prime Two), or some variation thereof. Both Gibson and Dixon's research seems to imply that warp drive was not available for general use until sometime shortly before the Fourth Earth-Kzin War. This begs the question: how did Terra and Kzin fight four interstellar wars across half of the Local Group in under two decades? Surprisingly enough, I found the answer in the "space warp" concept from the anime TV series *Star Blazers*. This suggested an intermediate step between impulse drive (aka advanced fusion, ion impulse, whatever) and true warp drive. The term *CDP generator* was borrowed from the *DS9 Technical Manual*, along with some of its background, to describe what I have come to call the "jump drive." This is a starship engine that is capable of a temporary FTL burst of speed and then has to wait until it can gather enough power for another "jump." Something like FASA's NTR drive from their old RPG. Remember, FTL technology has massive power requirements and simple fusion engines just weren't up to providing enough power for sustained cruising at FTL speeds. "Jump drive" would have been a workable compromise given the technology at hand. To use an analogy similar to that I used in discussing the issue on the FRS Forum, think of a high-tech racing car engine with a one gallon tank. No matter how snazzy and powerful that engine is, it's only going to go as far as that one gallon of fuel will last and then you've got to go buy some more. This *deus ex machina* also allows the Terrans, once they master the technology, to combine CDP generators with their spiked antimatter starship engines (*Columbus* class, *UES Icarus*) and come *very close* to true warp drive (*Liberty* class). All that would be left would be for Cochrane to work out the bugs with the matter-antimatter conversion, and presto! True warp drive. That's where Dixon's exhaustive research leads me on this issue. So, in brief, you have two fleets of starships equipped with various forms of "jump drive" duking it out in the Local Group for about two decades instead of two fleets of sublight starships chasing each other for two centuries or more. Overall it works out fairly well.

Something else that deserves mention is the nature of the Earth-Kzin Wars. They aren't really four separate wars at all. That's just how they were recorded in the Terran history books at the time. Instead, in the *TREK* universe, there were three successive waves of Kzinti attack fleets against humanity. Operation Rock Drop (which I moved to the third war to better fit in the *TREK* universe) put an end to these Kzinti staggered wave tactics for a few years. However, once they had sufficiently recovered, they scraped together everything they could for what they intended to be the fourth and final wave. Unfortunately for them, that was just about the time that the new warp drive ships of the Combined Fleets (*true* warp drive, not "jump drive") were entering service, which doomed the

Kzinti to failure before their first assault. This interpretation reconciles reasonably well with Sulu's statement from "The Slaver Weapon": "The Kzinti fought four wars against humankind and lost every one of them."

Some other quotes and points from "The Slaver Weapon" on which I've tried to key for this issue of the FSC:

"Are you forgetting that Kzinti females are dumb animals?" – My description of the *kzinretti* differs in only one point. It was modified to take into account the occasional genetic mutation that would result in one being intelligent. There are the occasional rare intelligent *kzinretti* in Known Space.

Chuft-Captain – Follows Niven's rules for Kzinti names. I followed the same lead in my character of Zrath-General, military governor of occupied Alpha Centauri.

"The last [war] was 200 years ago." – The episode took place in 2264; the last battle of the Fourth Earth-Kzin War was fought in 2064. The Treaty of Sirius was signed the following year in 2065.

"My crew has yet to taste human flesh as our ancestors did. We would welcome the opportunity." – Death of Lt. Radetski in the *Sakharov* Incident in FSC #3, the occupation of Alpha Centauri and their implied "culling" of its population (and that of the Tellarites) in this volume.

"Always you have had superior equipment." – Innovative use of mass drivers (First War), development of the particle cannon (Second War), the spiked antimatter CDP drive (Third War), the "Builder" artificial wormhole generator (Third War), and true warp drive (Fourth War).

Spock's speech about his attack on Chuft-Captain – A more eloquently short description of male *kzin* pride has yet to be written. I've touched upon the same points in my much longer discussion.

"If the Kzinti had [the Slaver weapon] the whole galaxy would be their dinner table!" – As it once was before the Earth-Kzin Wars. Both the Kzinti and Zrath-General make similar "dinner table" references.

"The Klingons or some other species would have tried to possess [the weapon]." – It is from this quote that the folks behind *Star Fleet Battles* apparently derived the notion that the Kzinti and the Klingons knew each other. I'll freely admit that this is a *very liberal* interpretation; however, I see no reason not to go with it. Hence I have followed the lead of both SFB (as illustrated on both the *Star Trek Maps* and the Okuda-

influenced *Star Trek Star Charts*) in having them be past enemies.

"That ancient war could have sparked a new war between man and Kzinti." – There will eventually be a Fifth Earth-Kzin War, and that is Todd Guenther's Kzinti Incursion of 2272. You can count on me giving it more than lip service when the time comes.

"At this rate, they'll never get over those old superstitions." – Such as praying to the Great-Fanged-One (per the material from Jimmy Diggs).

There are obvious parallels between the Earth-Kzin Wars in the *TREK* universe and the Pacific Campaign between the United States and Japan during World War II. I freely admit to looking to the latter for inspiration in trying to describe the former. This is from where the idea of "planet hopping" comes for the UESF offensive during the Third Earth-Kzin War. General Dietrich followed the example of MacArthur and Nimitz's strategy against the Japanese, "island hopping" from one strategic point to another and bypassing heavily fortified areas in favor of less defended ones. The bigger bases would then either be ignored altogether or taken care of once they were completely surrounded in an American sea. The difference between the two, of course, is that Dietrich and UESF were doing this on an interstellar scale. The Third Battle of Alpha Centauri and Operation Rock Drop are the bookends to Dietrich's "planet hopping" campaign.

Operation Rock Drop brings to culmination a subplot I started all the way back in Volume 01 about alien technology discovered on Mars. I foresaw the need for this back when I began this project, knowing that I would have to find a way to explain this event within the context of the *TREK* universe somehow. While "the cat is out of the bag" now, so to speak, I deliberately left out all but the barest of details in providing the frame for the subplot concerning Colonel Christopher's "Builders" and the artificial wormhole generator left behind on Mars. I leave it to *TREK* fandom and the franchise writers to fill in the blanks as they see fit. So who were the "Builders?" The Preservers? The Ikonians? Some other culture? Why did they come to the Sol System? Why Sidona, not to mention the wormhole generator? Are their others? Where are the "Builders" now? Do they still exist? What happened to them at Iapetus? What did the UESF do with the rest of the "Builder" technology found at Sidonia (and probably other places, too)? We may never know. It's always nice to have a few unsolved mysteries kicking around. They keep us humble by reminding us that we are just one small piece in a vast cosmic puzzle whose pattern and purpose we may never fully understand.

I forgot to mention this in the materials for Volume 03 but the Kzinti that attacked the *Sakharov* had a telepath among their crew. He was in the process of probing the minds of the captive crewmembers when Donets and Shkvarzev attacked with a homebrew sonic disruptor. They cranked it up to a frequency

that only the Kzinti could hear, so high and painful that it turned out to be deadly for most of them. I had to skip that part because I was running out of space in that section. That's also how humanity learned all about those neurotic Kzinti telepaths for the first time.

Have you ever noticed that in "The Slaver Weapon" each of the Kzinti aboard the *Traitor's Claw* have distinct facial features?

I had to guess on everything regarding the Kzinti patrol cruiser. What I came up with is a mix of Known Space and *Star Fleet Battles*. The lasers are mounted in the forward "nose cluster." The large "bumps" are part of the polarized graviton drive; they help generate the graviton field around the ship. The small "bumps" are doors for the missile racks (hence the insanely large number of missiles compared to a Terran ship). The "engine" in the back is the main cooling vent for the graviton drive, so one shot up its ass and a Kzinti patrol cruiser goes BOOM! The "legs" are landing struts that fold inward on takeoff, giving the ship its jellyfish-like appearance. The overall dimensions are a best guess based on Paul Lloyd's render from "The Warriors" that I included back in Volume 03.

Once again, credit goes to the FRS Forums for helping me flesh out the reasons why Kzinti ships carry such an insane number of drones. Apparently this goes back to the days of the old Kzinti Empire, right after they stole their "jump drive" technology from the Tellarites. The power requirements for its use put such a strain on the engines of their ships at the time that they were virtually helpless once they slowed from FTL speed to space normal speed. They needed some form of weapons technology independent of ship's systems to defend themselves during this critical time in case they were attacked. Warhead-equipped drones were an obvious choice due to their self-contained nature. Not surprisingly, a lot of veteran *Star Fleet Battles* players are voicing support for this premise. It apparently clears up this issue in their iteration of the *TREK* universe as well.

The occupation and eventual liberation of Alpha Centauri (aka "Wunderland") is mentioned repeatedly in the Known Space stories. This I also translated into the *TREK* universe with the appropriate reduction in timeframe. The idea of Kzinti military governor Zrath-General came from artist R. J. Bartop's line drawing of a Kzinti warrior named Zrath he had posted on his website. It's one of the few Kzinti images I've manage to find, other than the wonderful work of illustrator Court Jones, which evokes the TAS image of the Kzinti while at the same time staying true to their Known Space origins. The Combined Forces campaign to liberate Alpha Centauri is loosely based on the American conquest of Okinawa near the end of World War II, with the already massive casualty figures upsized considerably to reflect a fight on a planetary scale.

The "rogue planetoid" at which the Combined Forces offensive against the Kzinti ground to a halt until Operation Rock Drop can be found on the *Star Trek Maps*, Chart B. It's the same planetoid that would eventually become Wrigley's Pleasure

Planet. Well, on second thought it might not be the *exact* same planetoid, but it's in the same area. It was also the only marked place on the maps halfway to the heart of the old Kzinti Empire.

By the way, the Treaty of Sirius is based on a similar treaty in Known Space called the MacDonald-Rishshi Treaty. The former ended the fourth and last of the Earth-Kzin Wars in the *TREK* universe, while the latter only ended the first war in Known Space. The "annexation" of Kzinti space by humanity also comes from Known Space and makes perfect sense once you think about it. This also plays right into the long-term designs of the Vulcans, who are in effect *TREK's* "Puppeteers" at this time.

The business about the little scandal over the "suggestive" nose art on the *Black Mamba* class destroyers was suggested by a similar event in real life back at the end of the 20<sup>th</sup> century. The Air Force and Air National Guard, after years of protest over the "Vargas girl nose art" used by WWII bomber crews to boost morale, allowed plane crews to once again start using nose art so long as no suggestive images (i.e. "Vargas girls") were shown. I added the bit about *anime* girls given contemporary trends. Aridas is probably going to kill me "cheapening" the *Black Mamba* this way but I had precious little in the way of "real" data for the entry on this ship. On top of this, I had dug up several odd references to a covert Kzinti slave trade in young human females after the War and was looking for a way to explain it. It's a good bet that DY-X crews as well as most UESF small craft had their own nose art schemes that got canned for the same reason. It also gives any mesh artists who want to contribute to future revisions of the FSC a chance to ... ummm ... "have some fun" with some conceptual UESF nose art.

I know some of you may be scratching your heads involving the subplot of Hardigan's Ranger's and the eventual duel between Major Hardigan and Zrath-General. Yes, Kzinti despise females. Humanity doesn't, though, and *Major* Hardigan was a seasoned combat officer. I imagine she told Zrath-General, "The only way you're getting off this planet is through me." That was a direct swipe at Zrath-General's Kzinti pride in several ways. Suicide was out of the question. That same pride would not let him surrender nor let a female back-talk him like that. That's why he chose "the lesser of two evils" and attacked Hardigan's team, saving her for last. What he didn't count on was getting killed instead – and by a *female*, no less. He probably had to answer to the Great-Fanged-One for that screw-up, and I'll bet that wasn't a pleasant encounter.

The name for the *Valiant's* starship class, its sister ship *Defiant*, and the description of their mission paths come from Timo Saloniemi's *Hobbyist's Guide to the UFP Starfleet*.

Oh, one more thing. A lot of you have been catching and laughing at my little in-jokes and asides to other famous sci-fi stories and franchises along the way. I've slipped you quite a few in this issue. See if you can find them all.

- Richard



## SPECIAL THANKS TO:

---

ArcBuilder, Celestra, and StarGen  
Atolm  
Greg Jein  
Lawrence Miller  
Fred and Stan Goldstein  
Timo Saloniemi  
Aridas Sofia  
Rick Sternback

## KZINTI SOURCES:

---

Larry Niven (Kzinti and Known Space creator)

Atolm (Kzinti destroyer design)  
Bandai Entertainment (L-5 colony images from *Gundam*)  
Bastei-Lubbe GmbH (assorted Kzinti images)  
R. J. Bartop (Kzin warrior Zrath-General)  
Winchell Chung (*Leif Ericsson* schematics)  
D.T. Ericsson (*STAR TREK* themed Leif Ericsson images)  
Mateen Greenway (various space scenes)  
Walter M. Jeffries (*Leif Ericsson* concept)  
ITC Entertainment (SuperSwift pod and Hawk images)  
Court Jones (*The Lions of the Night* project artwork)  
Paul Lloyd (Kzinti patrol cruiser design and DY-X meshes)  
Russell Martin (Known Space Man-Kzin Wars Chronology)  
NewTek Systems ("7 Tango 7," as seen on *Babylon 5*)  
Retrovideo (*War of the Worlds* TV pilot painting)

## OTHER VISUAL SOURCES:

---

Gabriel Cubos  
Maateen Greenway  
Shane Johnson  
Geoffery Mandel  
Lawrence Miller  
New Eye Studio  
Rick Sternbach  
SpaceArt Archives

## CONTACT INFO:

---

Want to contribute to the *Federation Spaceflight Chronology*?  
You can find me on the FRS Online or Star Fleet Network  
forums. If you prefer direct contact then you can reach me at:

[rtrodude@yahoo.com](mailto:rtrodude@yahoo.com)



coming soon

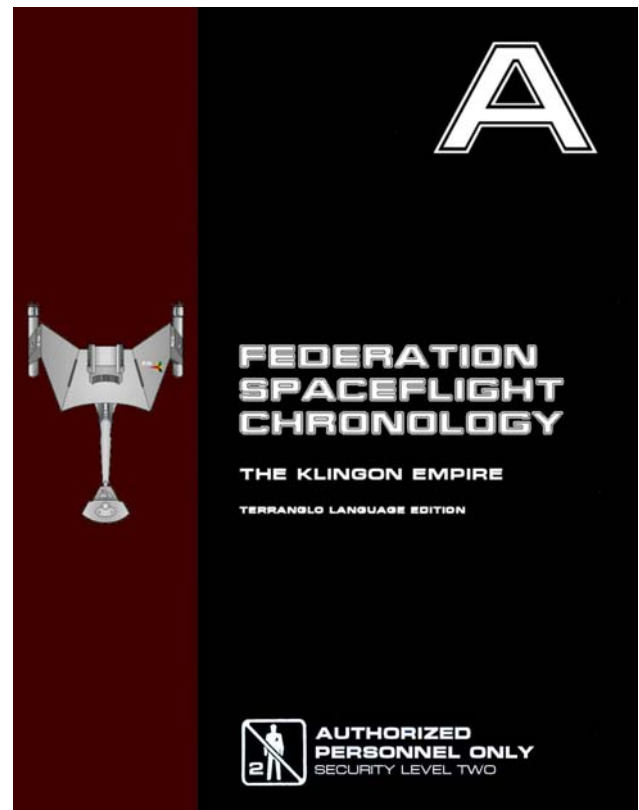

under development

